

SPECIFICATION SHEET
CARLO 750 1 DRAW WALL HUNG
SOLID SURFACE TOP

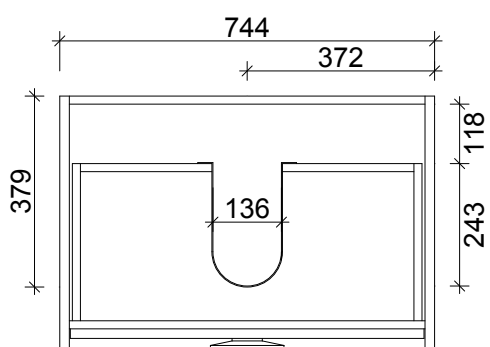

DRAWER WASTE CUT OUT

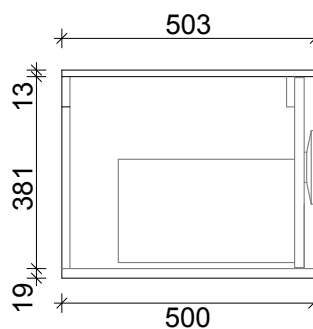
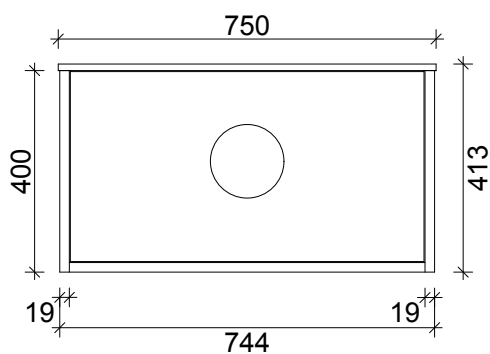

PRIMO BATHROOMWARE
3 EDISON PLACE
(03) 384-2471
EMAIL: enquiries@primobathroomware.co.nz