

SPECIFICATION SHEET
EDGE 750 1 DRAW OPEN SHELF WALL HUNG
SOLID SURFACE TOP

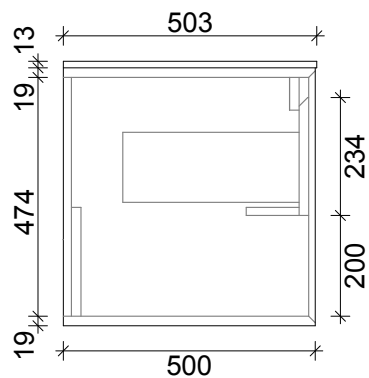
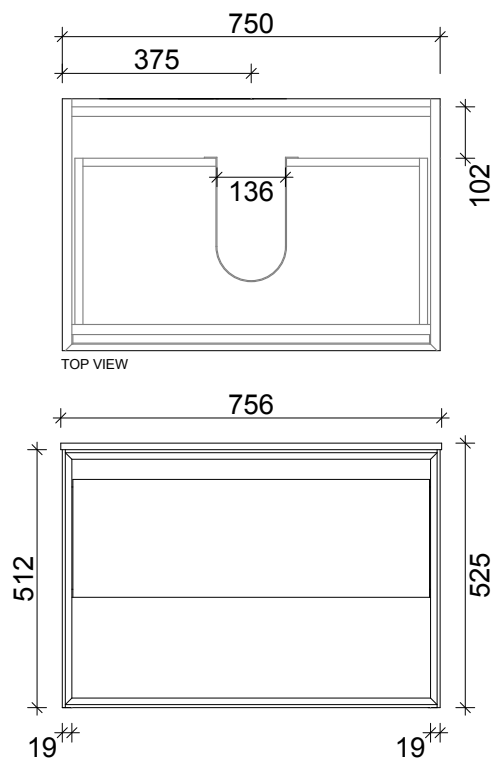

PRIMO BATHROOMWARE
3 EDISON PLACE
(03) 384-2471
EMAIL: enquiries@primobathroomware.co.nz