

SPECIFICATION SHEET
EDGE 900 2 DRAW WALL HUNG
SOLID SURFACE TOP

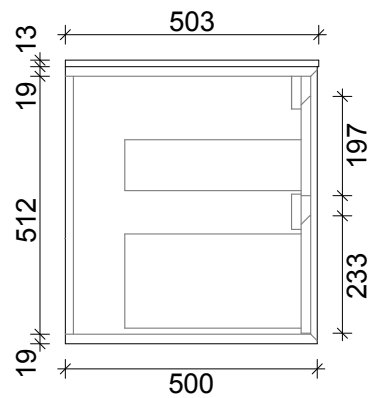
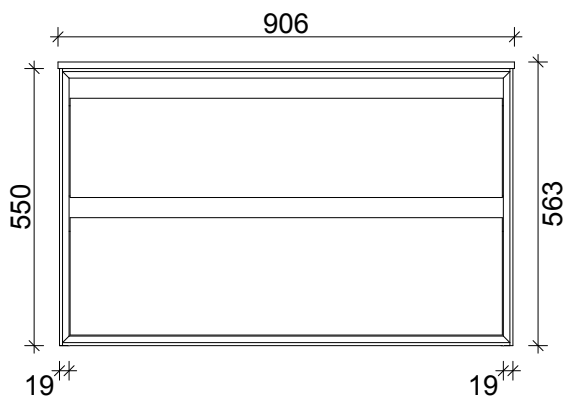
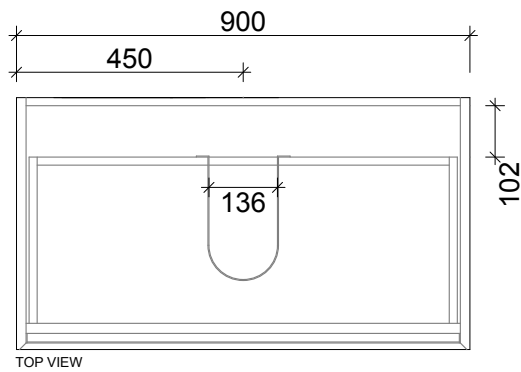

PRIMO BATHROOMWARE
3 EDISON PLACE
(03) 384-2471
EMAIL: enquiries@primobathroomware.co.nz