

**SPECIFICATION SHEET**  
EVO ARCO SLIM 1200 2 DRAW WALL HUNG

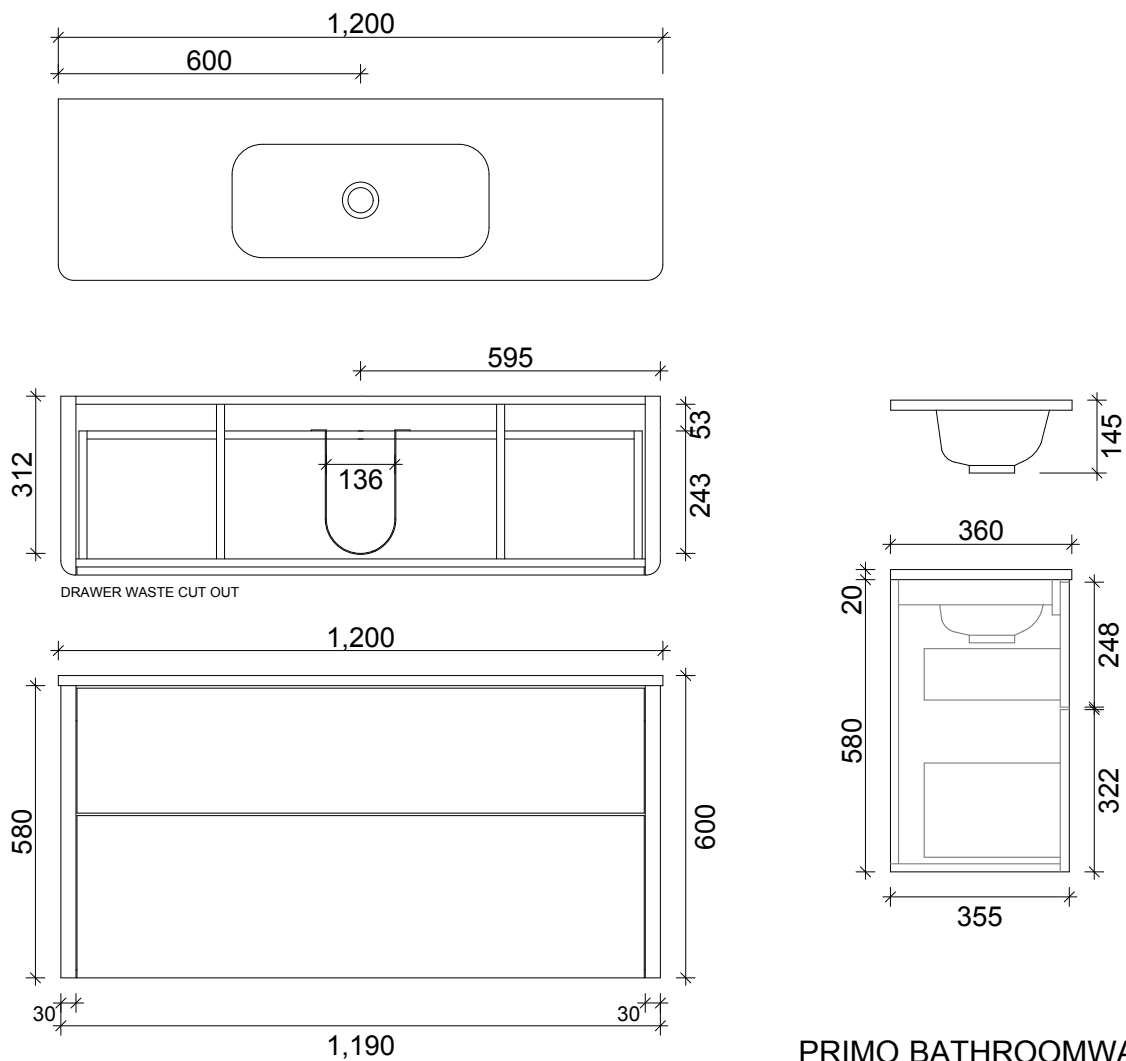

**PRIMO BATHROOMWARE**  
3 EDISON PLACE  
(03) 384-2471  
EMAIL: [enquiries@primobathroomware.co.nz](mailto:enquiries@primobathroomware.co.nz)