

# SPECIFICATION SHEET

PLATO 1200 2 DRAW WALL HUNG SOLID SURFACE TOP

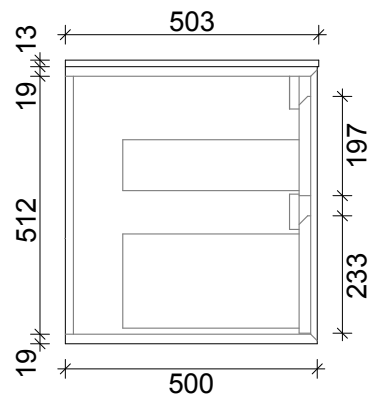
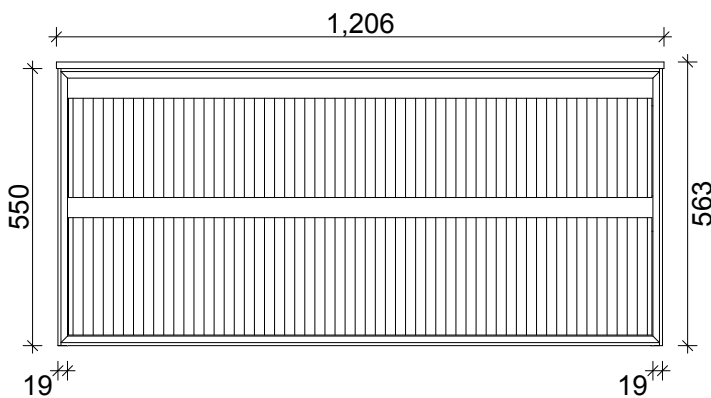
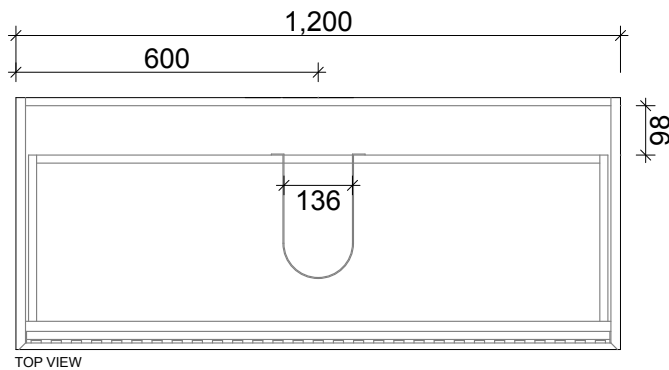

**PRIMO BATHROOMWARE**

3 EDISON PLACE

(03) 384-2471

EMAIL: [enquiries@primobathroomware.co.nz](mailto:enquiries@primobathroomware.co.nz)