

SPECIFICATION SHEET
PLATO 1800 4 DRAW SINGLE BASIN WALL HUNG
SOLID SURFACE TOP

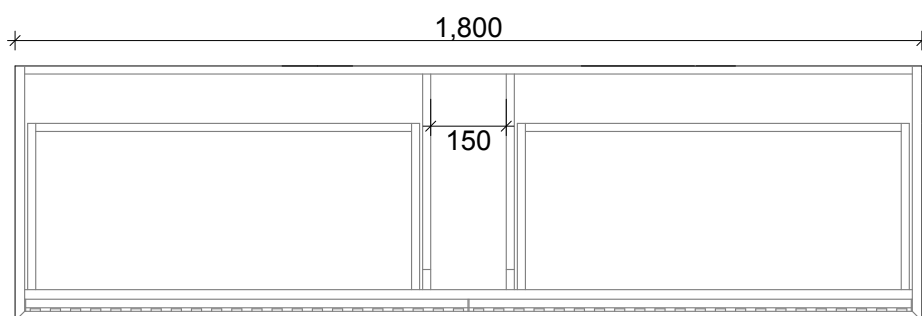

TOP VIEW

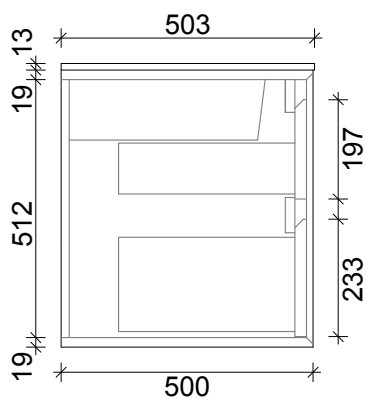
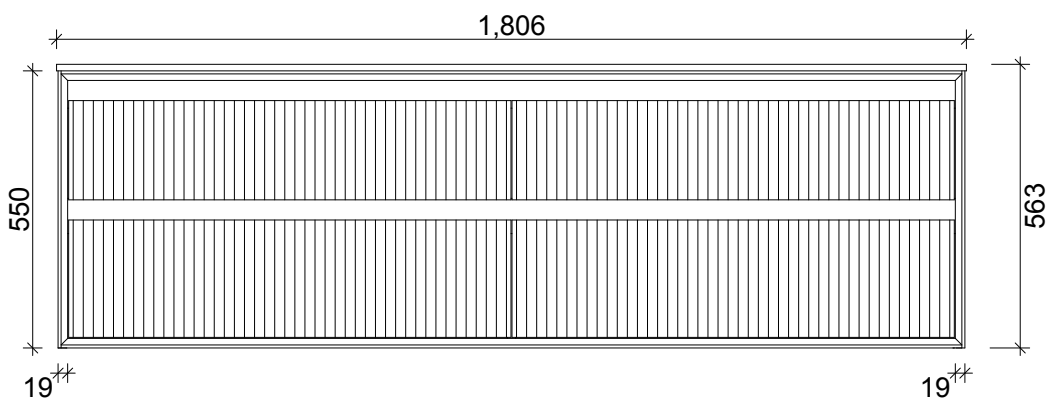

PRIMO BATHROOMWARE
3 EDISON PLACE
(03) 384-2471
EMAIL: enquiries@primobathroomware.co.nz