

**SPECIFICATION SHEET**  
PLATO 600 1 DRAW WALL HUNG  
SOLID SURFACE TOP

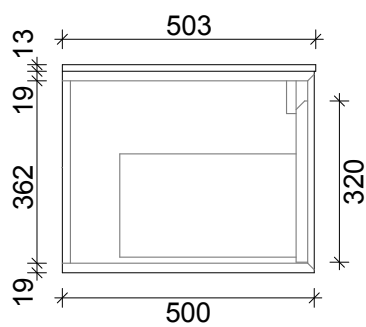
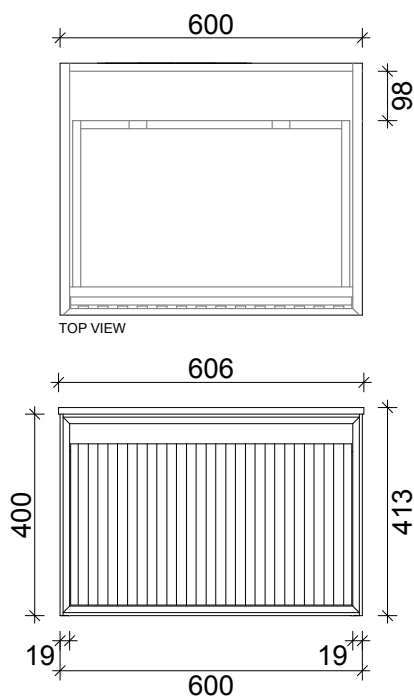

**PRIMO BATHROOMWARE**  
3 EDISON PLACE  
(03) 384-2471  
EMAIL: [enquiries@primobathroomware.co.nz](mailto:enquiries@primobathroomware.co.nz)