

# SPECIFICATION SHEET

## Porscha 1500 2-Drawer Double Basin Wall Hung Vanity



### Features

- 2-Drawer Wall Hung Vanity - *Colour options below*
- StoneCast 20mm Via Single Basin [Standard]
- Full Extension Soft Close Drawers with Extrusions - *Extrusion upgrade options available*
- Designer Drawer Fronts - *Four Drawer Front options*
- Dimensions: H420 x W1500 x D465

### Cabinet Options

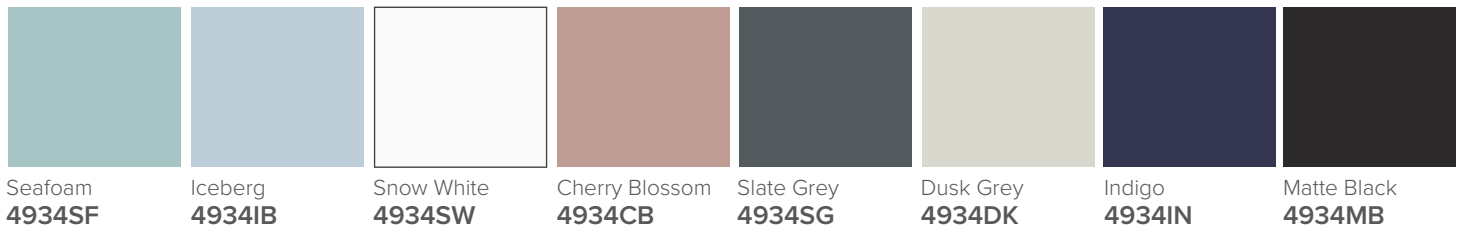

### Technical Details

Note: All measurements shown are in millimetres. Sizes are nominal.

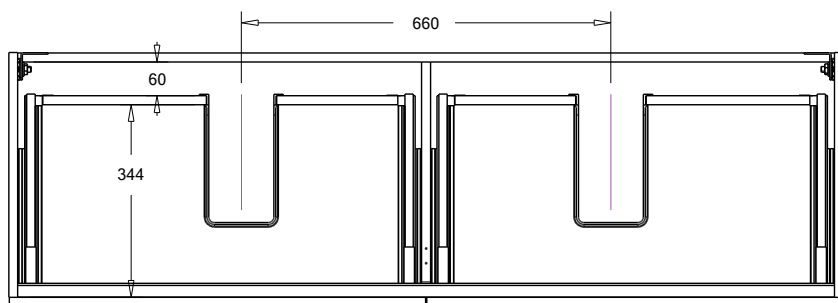

TOP VIEW

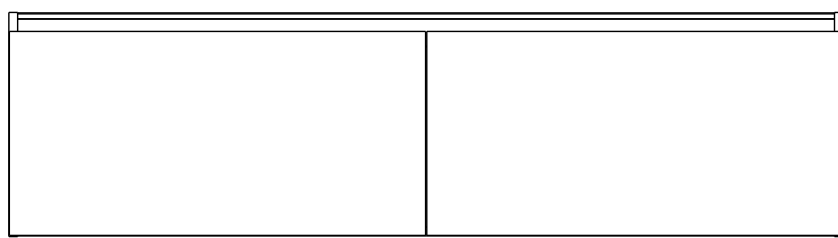
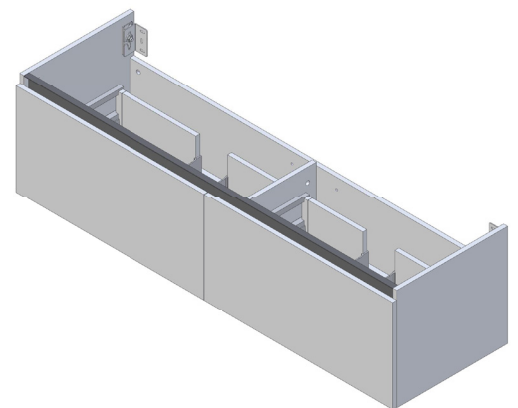

FRONT VIEW

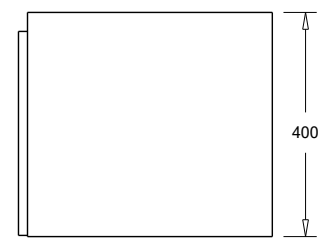

SIDE VIEW

# SPECIFICATION SHEET

## Porscha Designer Drawer Fronts

**BARNSLEY**  
18mm Inset Frame  
Code: BL

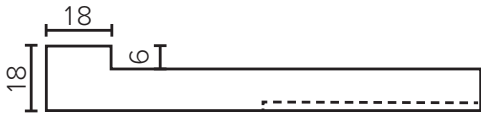
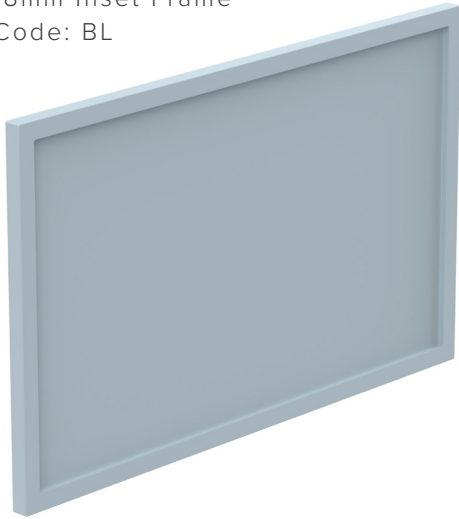

**PRESTON**  
60mm Inset Frame  
Code: PT

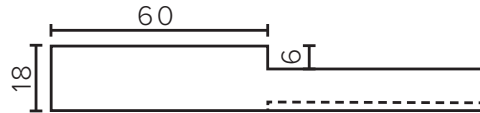
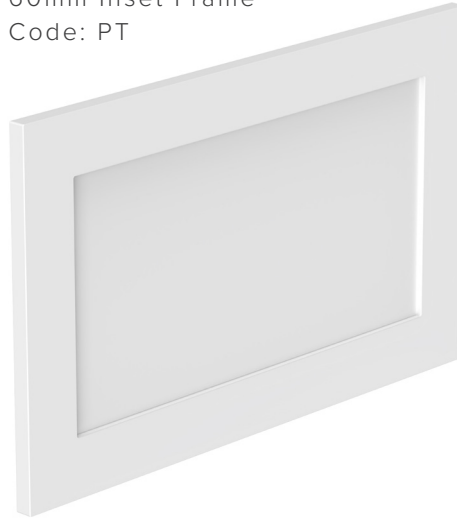

**TURNBERRY**  
Ripple Design Panel  
Code: TB

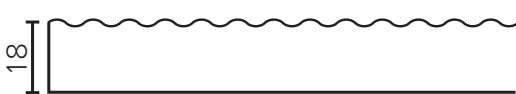
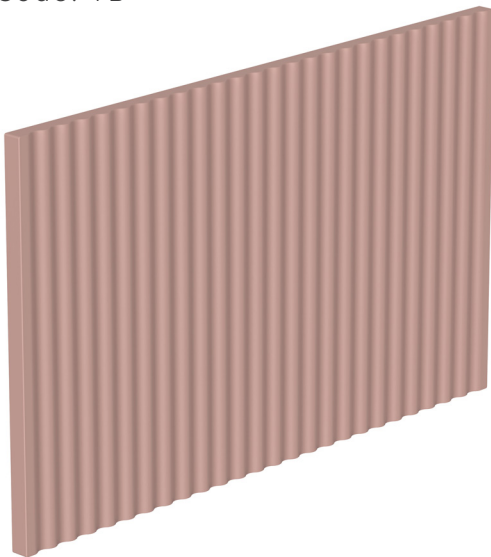

**NEWPORT**  
V-Groove Panels  
Code: NP

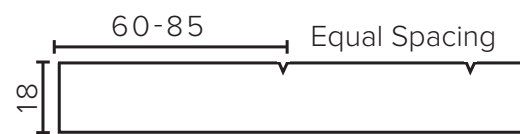
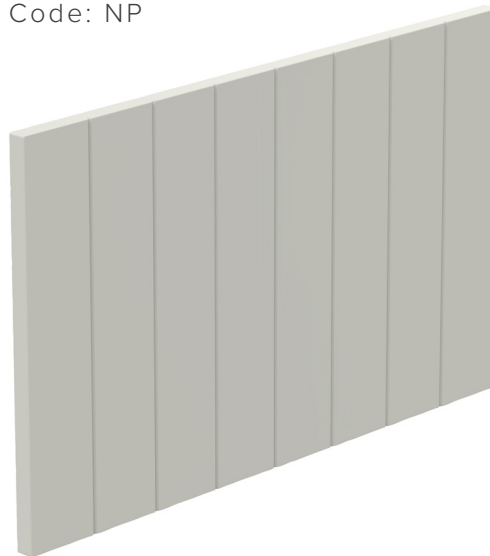

Seafoam



Iceberg

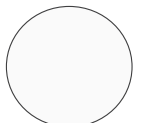

Snow White



Cherry Blossom



Slate Grey



Dusk Grey



Indigo



Matte Black

# SPECIFICATION SHEET

## 1500mm Double Basin Options

### Via

StoneCast with overflow  
Double Basin Option  
Gloss White - VIA  
Matte White - VIAMW

W1500 x D460 x H20

