

# SPECIFICATION SHEET

## Porscha 400 1-Door Wall Hung Vanity



### Features

- 1-Door Wall Hung Vanity - *Colour options below*
- 50mm StoneCast Interchangeable Basin
- Push-to-Open Door - Left or Right Hinge
- Designer Door Front - *Four Door Front options*
- Dimensions  
Cabinet: H350 x W392 x D218  
Basin: H50 x W400 x D225

### Cabinet Options

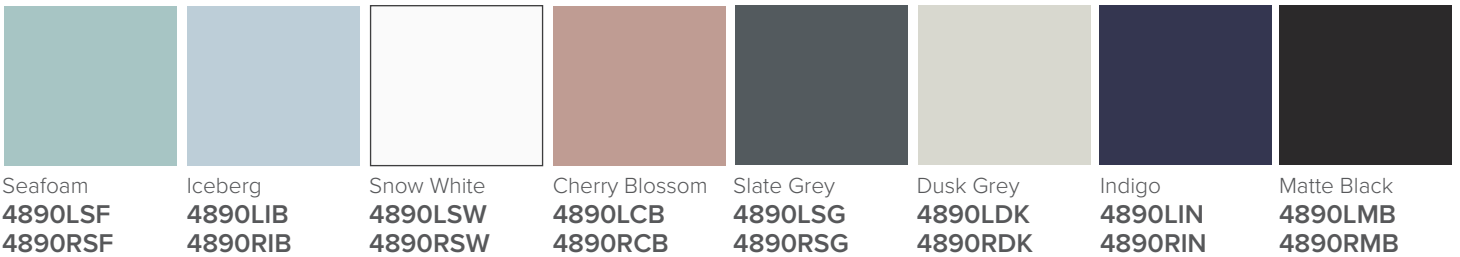

### Technical Details

Note: All measurements shown are in millimetres. Sizes are nominal.

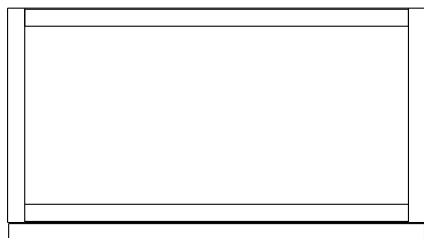

TOP VIEW

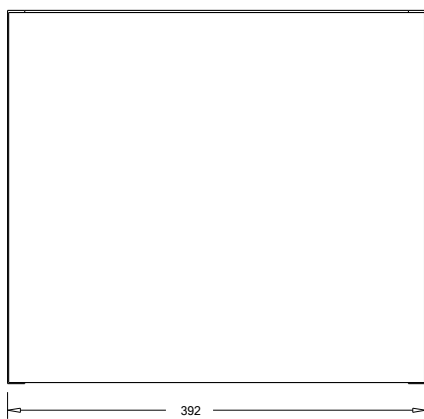

FRONT VIEW

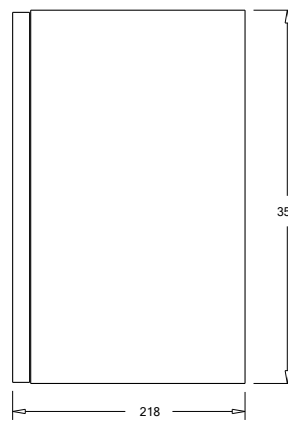

SIDE VIEW

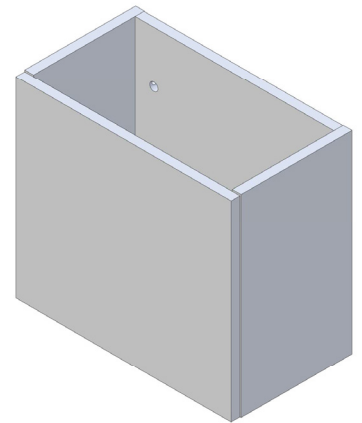

# SPECIFICATION SHEET

## Porscha Designer Drawer Fronts

**BARNSLEY**  
18mm Inset Frame  
Code: BL

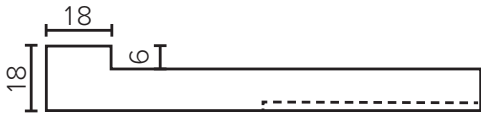
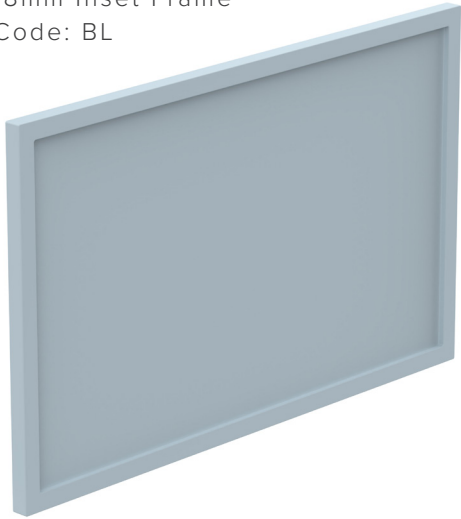

**PRESTON**  
60mm Inset Frame  
Code: PT

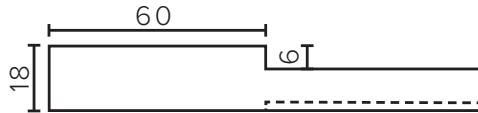
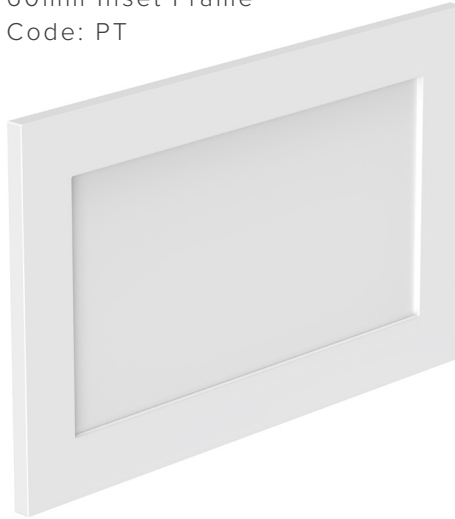

**TURNBERRY**  
Ripple Design Panel  
Code: TB

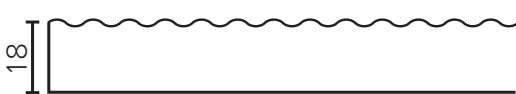
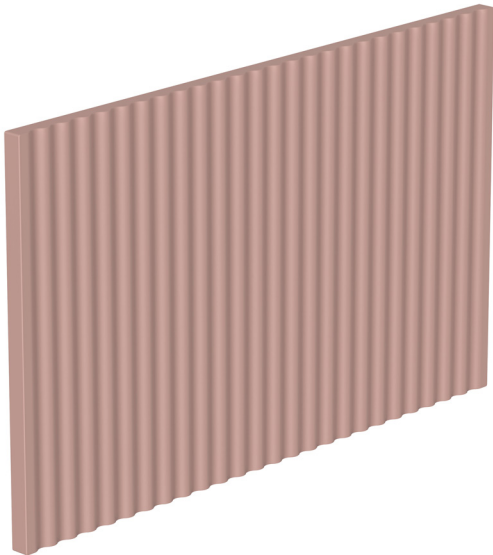

**NEWPORT**  
V-Groove Panels  
Code: NP

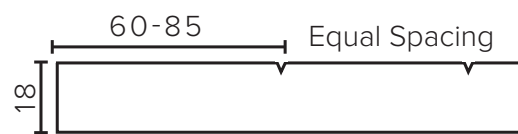
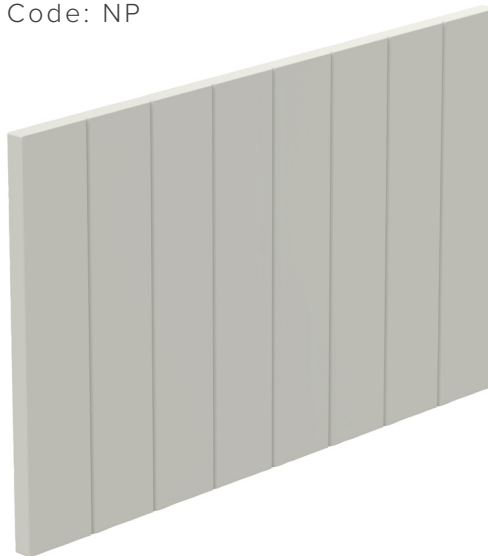

Seafoam



Iceberg

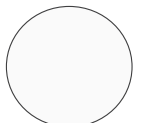

Snow White



Cherry Blossom



Slate Grey



Dusk Grey



Indigo



Matte Black