

SPECIFICATION SHEET

Porscha 750 2-Drawer Wall Hung Vanity



Features

- 2-Drawer Wall Hung Vanity - *Colour options below*
- StoneCast 20mm Via Basin [Standard]
- *Upgrade options available*
- Full Extension Soft Close Drawers with Extrusions
- *Extrusion upgrade options available*
- Designer Drawer Fronts - *Four Drawer Front options*
- Dimensions: H670 x W750 x D465

Cabinet Options

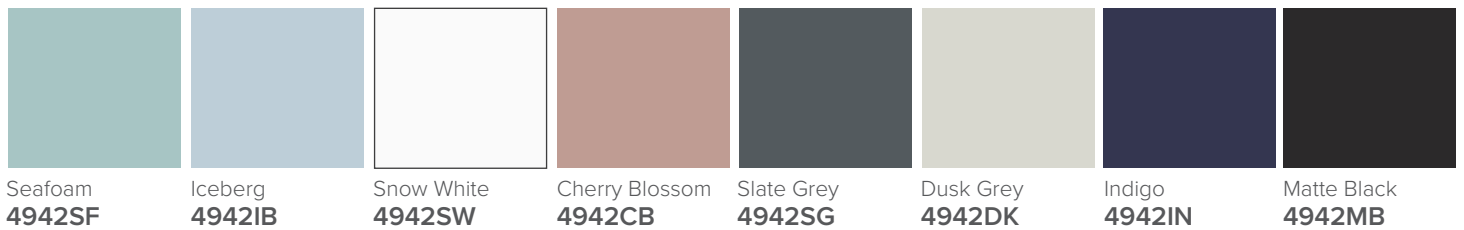

Technical Details

Note: All measurements shown are in millimetres. Sizes are nominal.

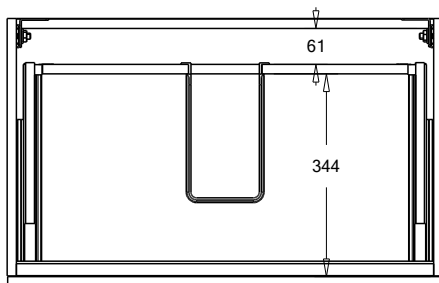

TOP VIEW

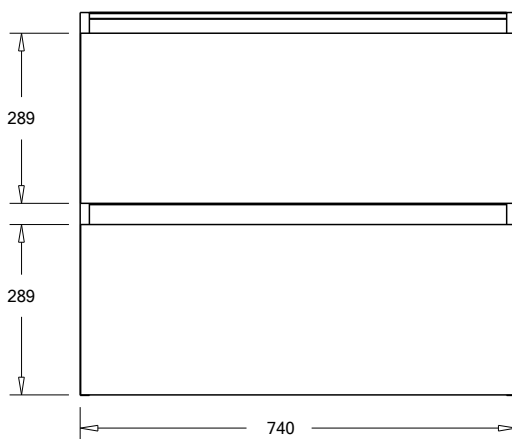

FRONT VIEW

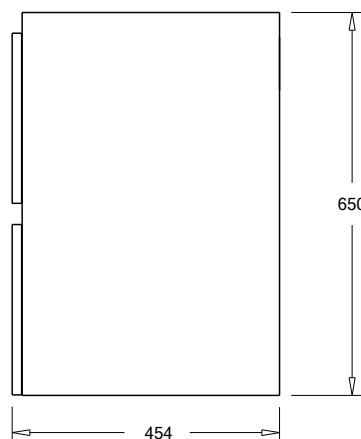

SIDE VIEW

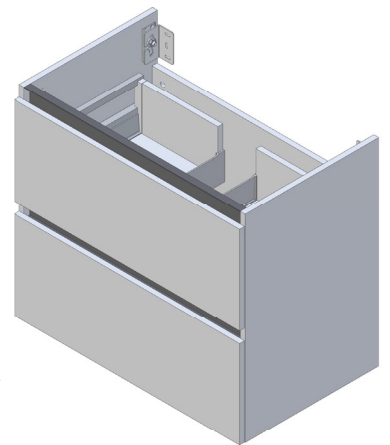

SPECIFICATION SHEET

Porscha Designer Drawer Fronts

BARNSLEY
18mm Inset Frame
Code: BL

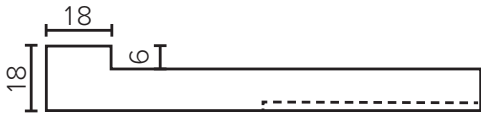
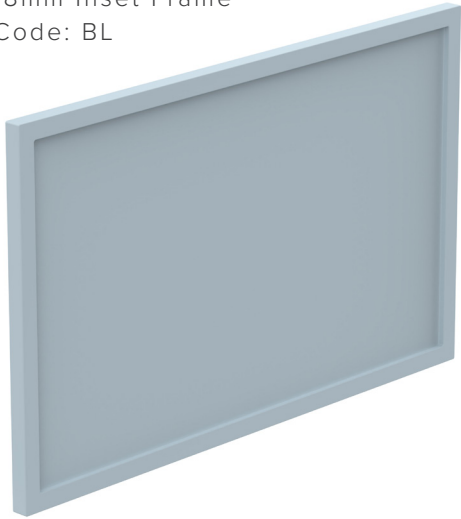

PRESTON
60mm Inset Frame
Code: PT

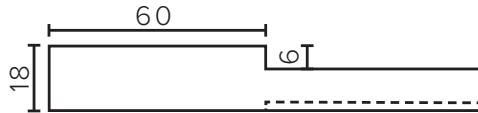
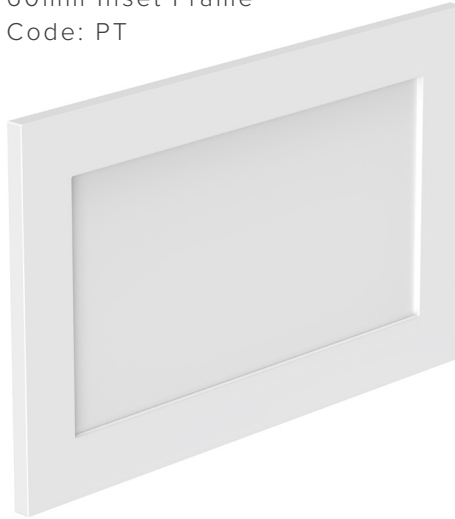

TURNBERRY
Ripple Design Panel
Code: TB

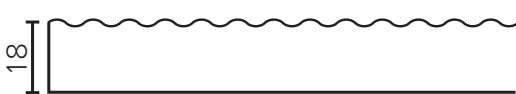
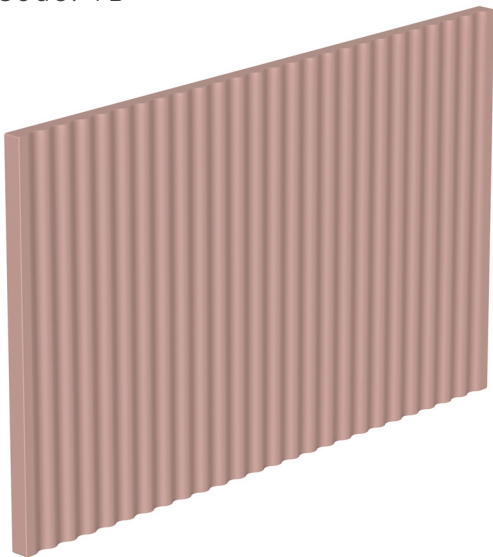

NEWPORT
V-Groove Panels
Code: NP

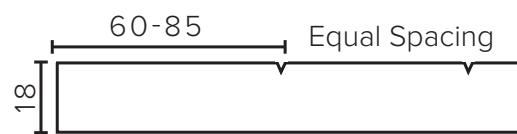
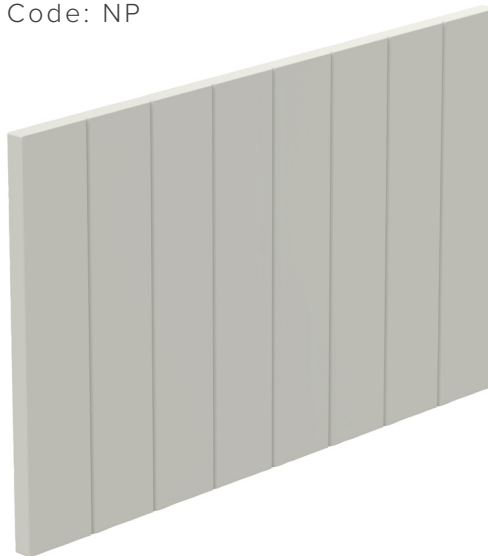

Seafoam

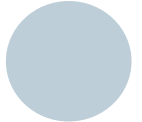

Iceberg

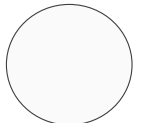

Snow White



Cherry Blossom



Slate Grey



Dusk Grey



Indigo



Matte Black

SPECIFICATION SHEET

750mm Basin Options

Via

StoneCast with overflow
Gloss White - VIA
Matte White - VIAMW

W750 x D460 x H20

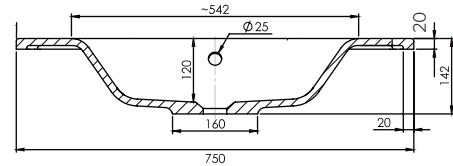
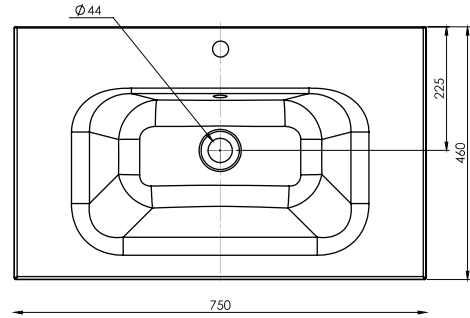
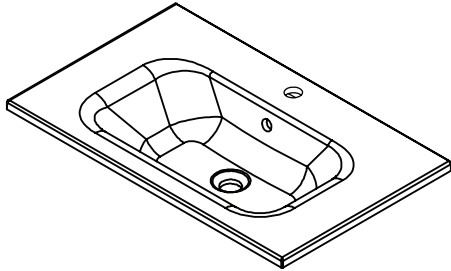

Clasico

Vitreous China with overflow
Gloss White - VC

W760 x D465 x H20

