

SPECIFICATION SHEET

Porscha Luxe 1500 2-Drawer Double Basin Wall Hung Vanity

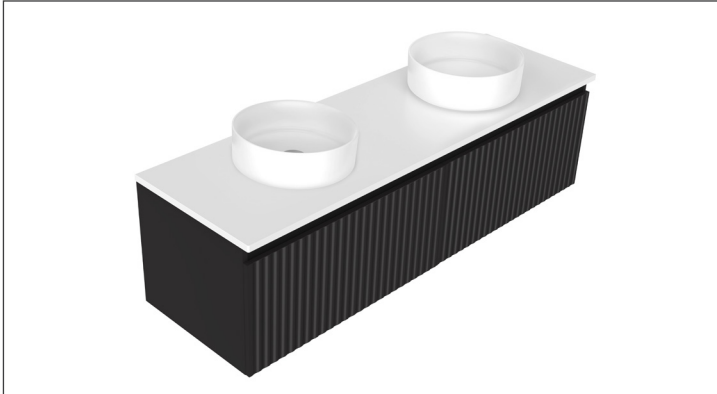

Features

- 2-Drawer Wall Hung Vanity - Colour options below
- Full Extension Soft Close Drawers with Extrusions - Extrusion upgrade options available
- Designer Drawer Fronts - Four Drawer Front options
- Dimensions: H420 x W1500 x D465
- Slab Top Options:
20mm StoneCast Top or Quartz Slab Top

*Note: Vessel basins are purchased separately.
Visit www.newtech.co.nz for the full range of vessel basin options.*

Cabinet Options

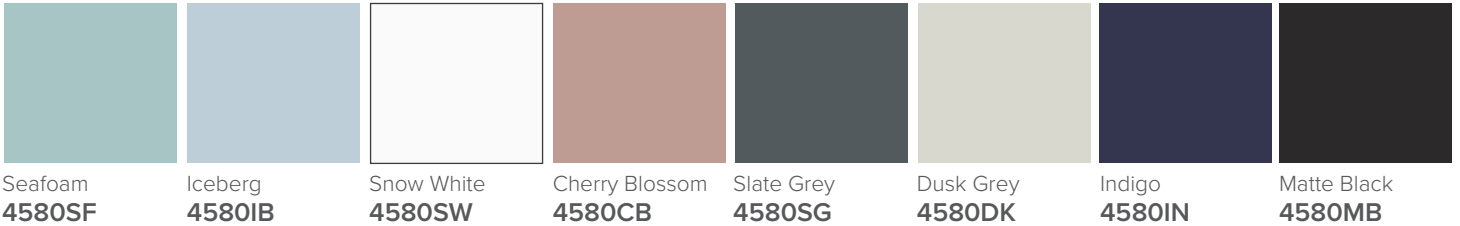

StoneCast Slab Top Options



Quartz Slab Top Options

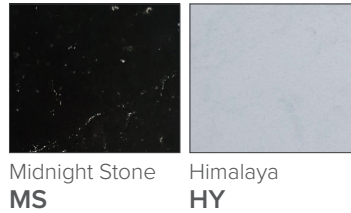

Note: To order a Slab Top, add the Slab Top code to the cabinet code

Technical Details

Note: All measurements shown are in millimetres. Sizes are nominal.

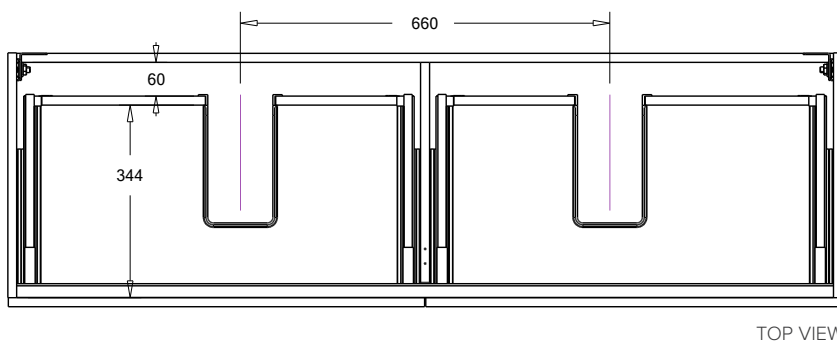

TOP VIEW

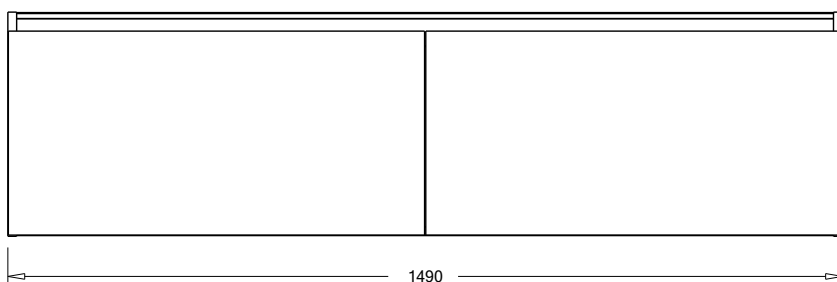

FRONT VIEW

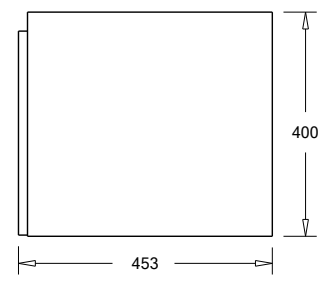
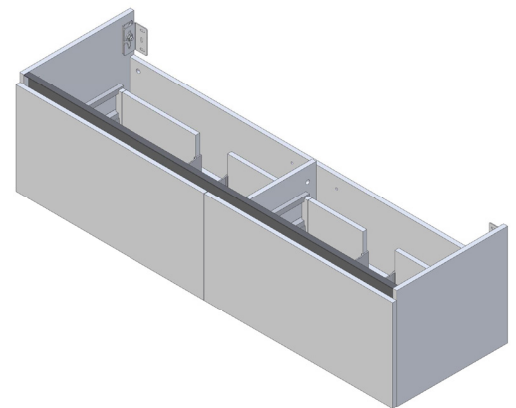

SIDE VIEW

SPECIFICATION SHEET

Porscha Designer Drawer Fronts

BARNSLEY
18mm Inset Frame
Code: BL

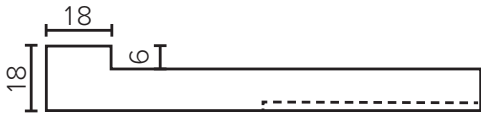
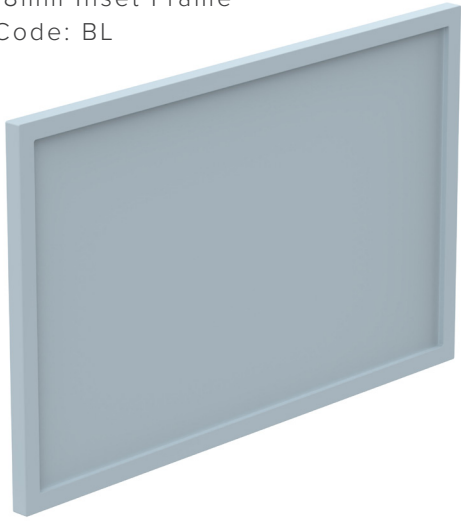

PRESTON
60mm Inset Frame
Code: PT

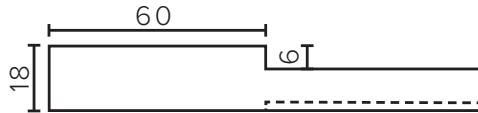
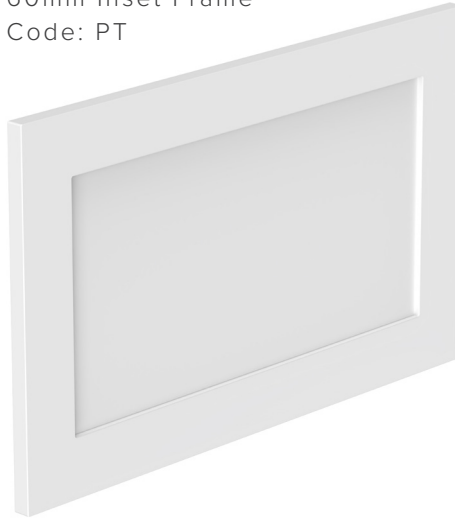

TURNBERRY
Ripple Design Panel
Code: TB

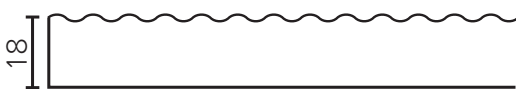
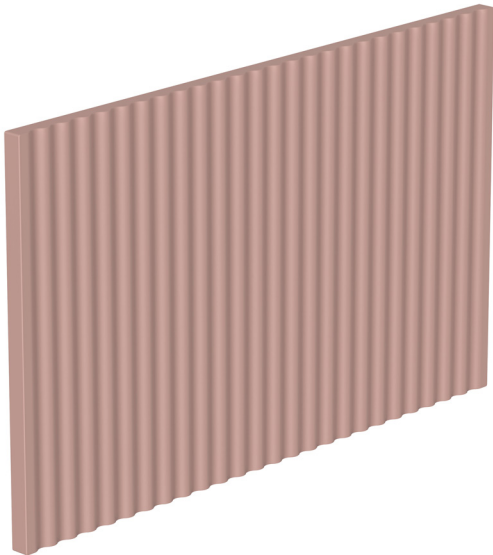

NEWPORT
V-Groove Panels
Code: NP

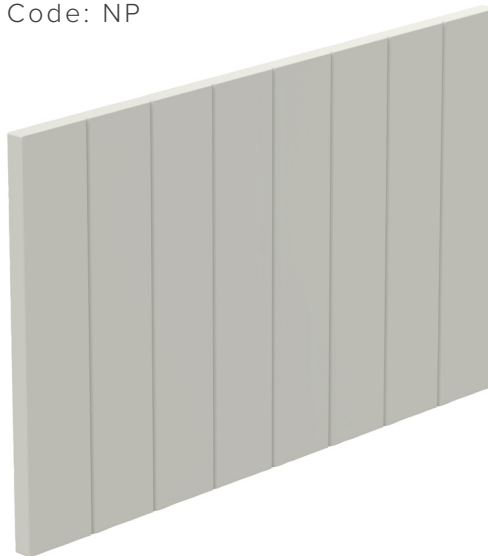

Seafoam

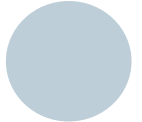

Iceberg

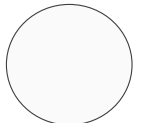

Snow White



Cherry Blossom



Slate Grey



Dusk Grey



Indigo



Matte Black