

SPECIFICATION SHEET

Vega 900mm 2 Drawer Wall Vanity



Features

- Wall Hung
- Full Extension Soft Close Drawers
- Negative detail finger pull with extrusion
- Cabinet:
Laminate Woodgrain & Solid Colours on MR Board
- Slab Top Options:
20mm Quartz Top or StoneCast Top
- Dimensions: H670 x W900 x D465
- Plumbing provision has been allowed for with a 60mm space behind lower drawer. Note lower drawer DOES NOT have a plumbing cutout and is designed to offer full storage space

*Note: Vessel basins are purchased separately.
Visit www.newtech.co.nz for full range of vessel basin options.*

Colour Options with Code

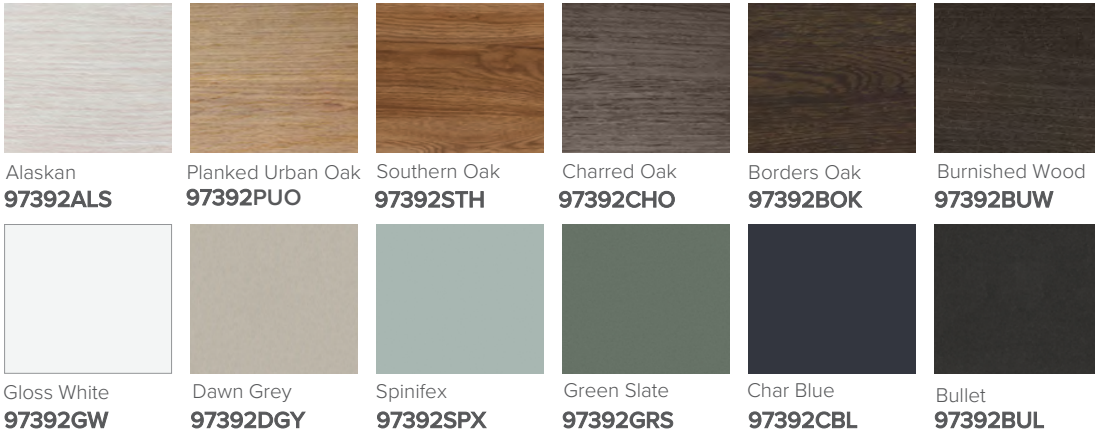

Technical Details

Note: All measurements shown are in millimetres. Sizes are nominal.

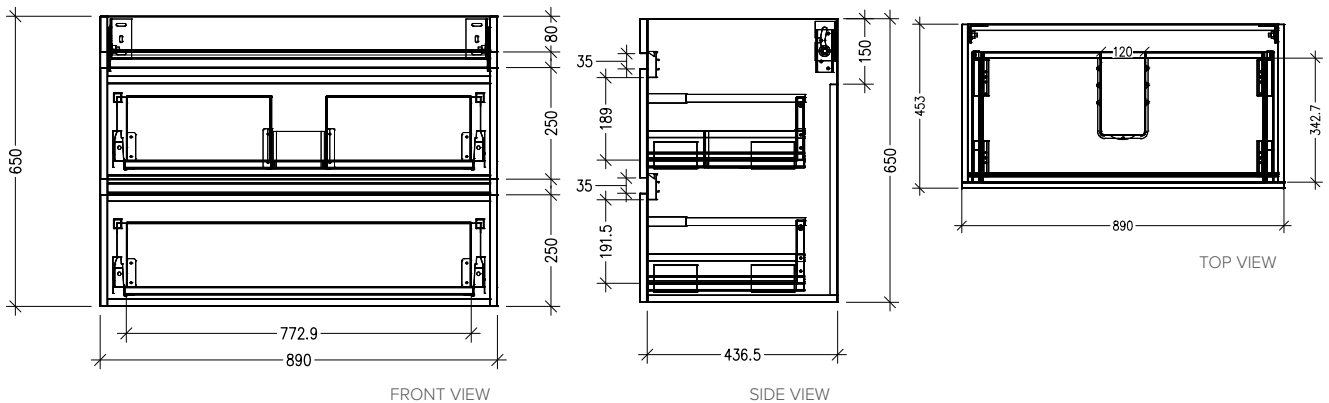

SPECIFICATION SHEET

Slab Top Options

StoneCast Slab Top 900

W900 x D465 x H20

Gloss White - SC

Matte White - SCMW

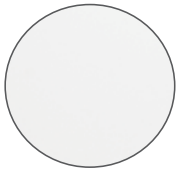
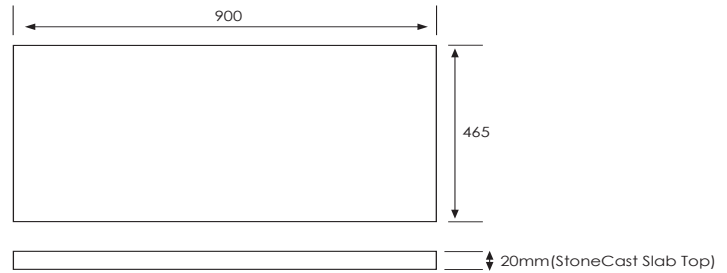
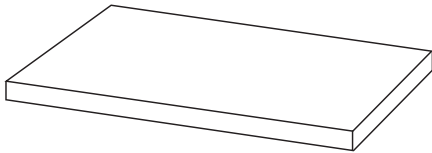

Gloss White



Matte White

Quartz Slab Top 900

W900 x D465 x H20

Midnight Stone - MS

Himalaya - HY

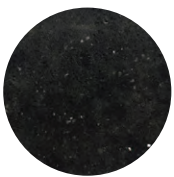
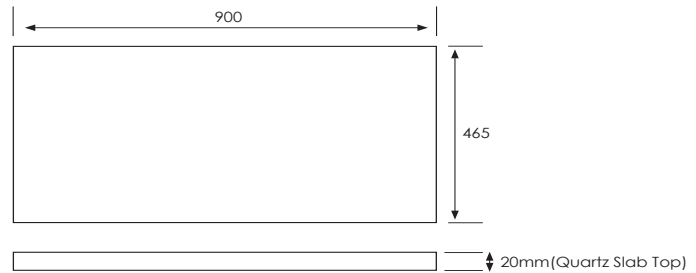
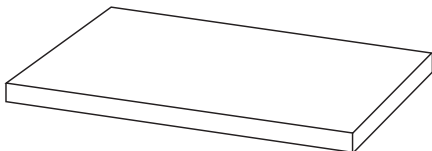

Midnight Stone



Himalaya

Tap Hole Position

Tap hole position must be specified

NTH	No Tap Holes
CTH	Centre Tap Holes
LTH	Left Tap Holes
RTH	Right Tap Holes
ITH*	Inside Tap Holes
OTH*	Outside Tap Holes

*only applicable with double basins