

INSTALLATION GUIDE

Thank you for choosing our flooring. When properly installed and cared for, your new flooring will be easy to maintain and will keep its great look for years. Please read all the instructions before you begin the installation. Improper installation will void the warranty.

Check-off each Item	Item	Standard	Why it is critical
	Subfloor flatness	Subfloor must be flat within 5 mm over 3 m.	A non-flat subfloor can cause gapping, buckling, and damage to the locking system.
	Subfloor moisture	ASTM F2170 RH 80% ASTM F1869 3.63 kg/92 m ² CM 2.5%	Subfloor moisture can cause site-related issues which might lead to an installation failure, alkali salt buildup damage to joints, and a potential mold source. 0.15 mm poly sheeting is required on concrete substrates.
	Subfloor deflection	Subfloor must be structurally sound with no up-and-down movement.	Subfloor deflection will cause gapping and joint damage to the locking mechanism.
	Approved substrate	No soft substrates.	Additional soft underlayment is not to be used and will void the warranty. Cushioned vinyl, floating floors, and carpets are not suitable substrates. Vinyl flooring should never be installed over wood that is installed over concrete doing so will void the warranty.
	Inspect planks	Inspect planks to be installed closely for visible damage.	Prior to installation, inspect the material in daylight for visible faults/damage, including defects or discrepancies in color or shine; check the edges of the flooring for straightness and any damage. No claims on surface defects will be accepted after installation.
	Maintain appropriate expansion space	Floating floors must be free to move.	Improper expansion can cause cupping, gapping, and damage to the locking system. Don't hard butt flooring into door jams, walls and kitchens. Do not silicone perimeter of open plan rooms (wet areas only 15m² or less, please read instructions)

IMPORTANT NOTICE

All wood-based products, even those specifically designed to have increased resistance to moisture, are hygroscopic (they will react to the moisture in the environment) and as a result will expand or contract accordingly. All sources of under floor moisture must be rectified prior to the installation of the floor. Any construction dampness must be completely dry. It is important that you check each plank for any manufacturing defects. Any faults must be reported back to the store of purchase for an immediate refund or replacement prior to the flooring being installed.

I. PREPARATIONS

- Prior to installation, inspect material in daylight for visible faults/damage, including defects or discrepancies in color or gloss; check the edges of the flooring for straightness and any damage. No claims on surface defects will be accepted after installation.
- It is preferable to lay boards perpendicular to the window, following the direction of the main source of light. For the best result, make sure to always work from 3 to 4 cartons at a time, mixing the planks during the installation.
- Check if subfloor/site conditions comply with the specifications described in these instructions. If you are not satisfied, do not install, and contact your supplier.
- Flooring products can be damaged by rough handling before installation. Exercise care when handling and transporting these products. Store, transport and handle the cartons in a manner to prevent any damage. **Store cartons flat, never on edge.**
- Flooring products can be heavy and bulky. Always use proper lifting techniques when handling these products. Whenever possible, make use of material-handling equipment such as dollies or material carts. Never lift more than you can safely handle, get assistance.
- **Calculate the room surface prior to installation and plan an extra 10% of flooring for cutting allowance.**
- The flooring is intended to be installed in interior locations only. It is not to be installed in areas that are exposed to the elements, such as outdoor areas, semi-covered / "alfresco" outdoor areas, porches, etc.
- **Keep the boards at room temperature for at least 48 hours in unopened package before you start the installation.** Flooring should only be installed in temperature ranges between 18-30 °C and the relative humidity should be maintained between 30-65 % before and during the installation. Portable heaters are not recommended as they may not heat the room and subfloor sufficiently. Kerosene heaters should never be used.
- After installation the room temperature must be between 15-35 °C at 30-65 % relative humidity.
- For floor surfaces exceeding 200 m² and or lengths exceeding 15 m and overlaps to new rooms and floor surface which do not join symmetrically, use transition moldings leaving min ½" / 10 mm transition gaps.

II. SUBFLOOR INFORMATION

- The flooring can be installed over most existing hard surface floor coverings, provided that the existing floor surface is clean, flat, dry, securely fastened, structurally sound and level to 5 mm within 3 m radius.

- The product can be installed on substrates with grout joints or grooves if these are less than 5 mm in width and 4 mm in depth. Depressions, deep grooves, expansion joints and other subfloor imperfections that do not meet this requirement must be filled with approved patching & leveling compound prior to installation.
- Substrates must be free from excessive moisture or alkali. Remove dirt, paint, varnish, wax, oils, solvents, any foreign matter and contaminates.
- The subfloor must be dry. Comply with Mc requirements and tested as per one of below methods:
 - Concrete moisture vapor emissions should not exceed 3.63 kg MVER (moisture vapor emission rate) per 100 m² per 24 hours. This can be measured with the calcium chloride test (ASTM F1869).
 - 90 % RH (ASTM F2170) with a PH limit of 9.
 - Max. 2.5 % moisture content (CM method / ASTM F2659).
 -

Note: It is the floor covering installer's responsibility to make sure these tests have been conducted, and that the results are acceptable prior to installing the floor covering. When moisture tests are conducted, it indicates the conditions only at the time of the test. The floor should not be installed on subfloor with excessive moisture emission. Always use 0.15 mm poly-film as a moisture barrier between the subfloor and the flooring, failing to do so will void your warranty

WOOD SUBFLOORS

- If this flooring is intended to be installed over an existing wood floor, it is recommended to repair any loose boards or squeaks before you begin the installation.
- Wood subfloors must have no more than 12% Mc (moisture vapor content).
- Basements and crawl spaces must be dry. **Use of a 0.15 mm poly-film is required to cover 100% of the crawl space earth.**
- Lay the flooring crossways to the existing floorboards.
- All other subfloors - Plywood, OSB, particleboard, chipboard, wafer board, etc. must be structurally sound and must be installed following their manufacturer's recommendations.
- Double-layered APA rated plywood subfloors should be a minimum 25 mm total thickness, with at least 45 cm well ventilated air space beneath.

CONCRETE SUBFLOORS

- Existing concrete subfloors must be fully cured, at least 60 days old, smooth, permanently dry, clean, and free of all foreign material such as dust, wax, solvents, paint, grease, oils, and old adhesive residue.
- The subfloor must be dry. Comply with Mc requirements and tested as per one of below methods:
 - Concrete moisture vapor emissions should not exceed 3.63 kg MVER (moisture vapor emission rate) per 100 m² per 24 hours. This can be measured with the calcium chloride test (ASTM F1869).
 - 90 % RH (ASTM F2170) with a PH limit of 9.
 - Max. 2.5 % moisture content (CM method / ASTM F2659).

A minimum 0.15 mm poly-film as a moisture barrier must be used between the concrete subfloor and the flooring. The pre-attached underlay is NOT a substitute for a vapor barrier.

Failing to install a vapor barrier may result in squeaking floors and could promote mold growth, failing to do so will void your warranty.

DO NOT INSTALL OVER

- Any type of carpet.
- Existing cushion-backed vinyl flooring.
- Any type of floating floor.
- Hardwood flooring / wood subfloors that lay directly on concrete or over dimensional lumber or plywood used over concrete.
- If the floor has a pre-attached underlayment, the use of an additional underlayment could damage the locking mechanism and will void the warranty.

III. INSTALLATION

TOOLS AND SUPPLIES REQUIRED: Foam Underlay (if not pre-attached) / Spacers / Saw / Adhesive Tape 0.15 mm or thicker Poly-film Vapor Barrier / Ruler / Pencil / Tape Measure/ Pull Bar / Constructions Adhesive / Wedges / Tapping Block / Rubber Mallet

- **Remove baseboard, quarter-round moldings, wall base, appliances and furniture from room. Door Jamb must be under-cut to allow flooring to move freely without being pinched.** After preparation work, sweep and vacuum the entire work area to remove all dust and debris.
 - With a floating floor, you must always ensure you leave a 10 mm gap between walls and fixtures such as pillars, stairs, etc. When installing around pipes, drill the holes 20 mm larger than the diameter of the pipes.
 - **Do not install heavy fixed objects such as kitchen cabinets directly over the floor planks. The floating installation requires that the planks can move freely.**
 - **Do not hard butt flooring into kitchens or door jambs, these must be undercut**
 - **Do not silicone perimeter of flooring in open plan areas as the floor may fail**
 - **Do not pin the floor down with the skirting, allow flooring to move freely without being pinched.**
 - **Don't screw door stops through the flooring, use door stops that attach to the wall/skirting.**
 - **Failing to follow the above instructions may result in the floor failing.**
 - **UNDERLAY:** the use of an additional underlayment could damage the locking mechanism and will void warranty.
 - Whenever possible, plan the layout so that the joints in the planks do not fall on top of joints or seams in the existing substrate. The end joints of the planks should be staggered a minimum of 20 cm apart. Do not install over expansion joints. Avoid installing pieces shorter than 30 cm at beginning or end of rows.
 - Measure the area to be installed: The board width of the last row shall not be less than 50 mm. If so, adjust the width of the first row to be installed. In narrow hallways, it is recommended to install the floor parallel to the length of the hall.
 - Begin laying in the left-hand corner, with the grooved edge visible and facing outward. Use spacers between the wall and the floorboard in order to keep a 10 mm gap.
1. After thoroughly cleaning the subfloor, you should install a foam underlay (unless your product has a pre-attached pad). Run the foam underlay in the same direction as the flooring planks. The underlay should be butted side-by-side with no overlap. Tape seams together. If you are installing over a concrete subfloor, a 0.15 mm plastic poly sheeting is to be installed under the foam underlay.

NOTE: Many foam underlays already have this plastic sheeting pre-attached.

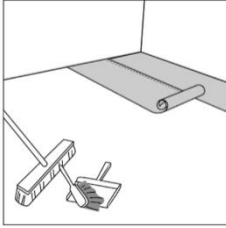

2. **First row, second plank:** Insert the end tongue on the short side of the second plank into the end groove of the first one and rotate downward to assemble. Make sure both planks are perfectly aligned.

NOTE: If you notice both planks aren't at the same height or are not well locked together, please follow the disassembling instructions at the bottom of the page, disassemble and check if any debris stuck inside the lock is obstructing.

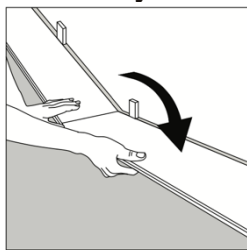

3. **At the end of the first row:** Leave a gap of 10 mm to the wall to avoid any damage while installing your floor and measure the length of the last plank to fit. Insert the short side and tap it closed, using a pull bar.

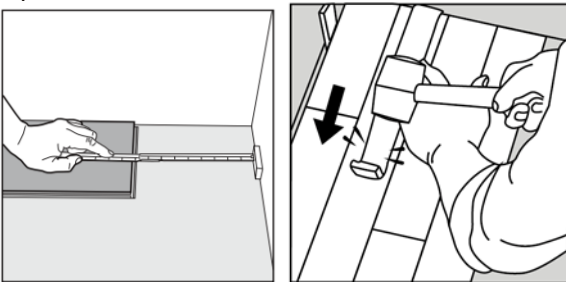

Cutting tip: If cutting with a jig saw, the laminate surface should be turned down. If cutting with a hand saw, the laminate surface should be face up.

IMPORTANT: When cutting this product please use a dust mask or other safeguards for personal protection, it is advised to cut in a well-ventilated area.

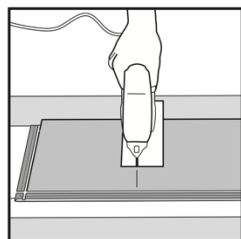

4. **Starting second row:** Rows can be started with end cuts if the cut plank is at least 30 cm long. If end cut is used for subsequent row a stair step pattern is established. Starting planks of random lengths will create a more aesthetic random stagger. Short end joints must not be closer than 20 cm to each other.

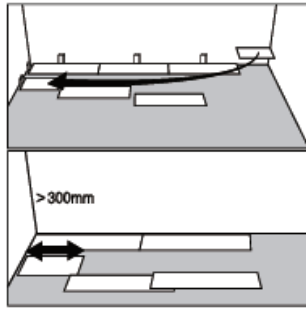

5. **Second row, first and second planks:**

- a) **Main Method:** At a slight angle click the long side of the plank into the previous row, slide it against the spacer on the wall on the left and place an installation wedge under the board. Place the short end of the plank at an angle against the short side of the previously installed floorboard and fold down. Slide down the long side of the board into the locking groove of the adjacent floorboard in the previous row. When the whole row is complete, remove the wedge and fold the row down. Use a tapping block or cutoff to gently tap along the long side until the joint is closed tightly.

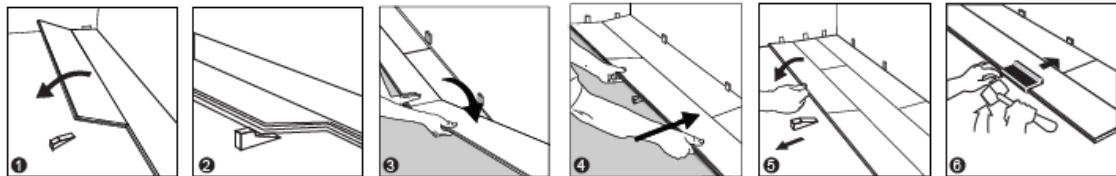

- b) **Alternative Method:** At a slight angle, click the long side of the first plank into the previous row and slide it against the spacer on the wall on the left. To complete the row, click the long side of the plank into the previous row at a slight angle and slide it close to the short end of the previous plank. Use a tapping block to gently tap along the long side until the joint is closed tightly, then tap in the short side of the second plank using the tapping block or cutoff into a locked position. Before tapping in the short side of the second plank, in order to make sure that adjacent planks are at the same height and aligned please use a cutoff plank as a bridge as shown on the image below, only then tap them in.

Note: Uneven tapping or use of excessive force may damage the joint.

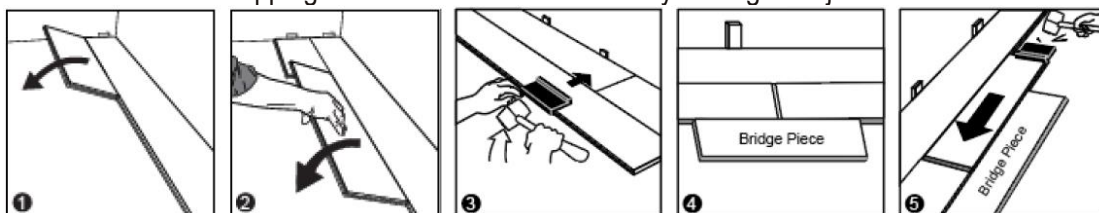

Tip: After finishing the installation of every row, use a tapping block or cutoff and a rubber mallet to gently tap the planks into the click of the previous row to make sure they are tightly clicked together and make sure there is no gap between the long side of the planks installed. Any gapping can compromise the whole installation.

6. **To lay the last row:** Position a loose board exactly on top of the last row laid. Place another board on top, with the tongue side touching the wall. Draw a line along the edge of this boards, to mark the first board. Cut along the edge of this board to mark the first board. Cut along this line to obtain of the required width. Insert this cut board against the wall. The last row should be at least 2" / 50 mm wide. Using a pull bar and hammer, work evenly along the length of the plank and lightly tap the joint

closed. The spacers can then be removed.

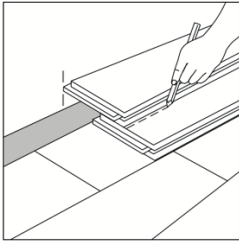

7. **Holes for pipes:** Measure the diameter of the pipe and drill a hole that is $\frac{3}{4}$ " / 20 mm larger. Saw off a piece as shown in the figure and lay the board in place on the floor. Then lay the sawed-off piece in place.

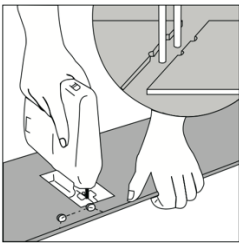

8. **Door molding and skirting:** Lay a board (with the decorative side down) next to the door molding and saw as shown in the figure. Then slide the floorboard under the molding.



FOR LOW RISK WET AREAS (NOT EXCEEDING 15M2)

It is important to seal any cut planks to ensure superior and warranted performance. When a flooring plank is cut to fit (either end cuts or side cuts), a sealant is always required around the perimeter of the installation.

- Fill the expansion spaces with a 10 mm compressible PE foam backer rod and cover with a flexible 100% silicone sealant to the entire perimeter of the installation. Do not use an acrylic sealant.
- Prior to installing moldings, apply silicone sealant to the portion of the molding or transition that will contact directly with the flooring surface.
- Install moldings and immediately wipe away any excess silicone sealant.
- Apply silicone sealant at connections to doorframes or any other fixed objects.
- Branded and generic silicone tubes are available in any local home center or hardware location.

IV. FINISHING THE INSTALLATION

Replace molding or wall base. Nail the molding to the wall surface, not through the flooring. In areas where the flooring planks may meet other flooring surfaces, the use of a transition molding is required to cover the exposed edge **but do not pinch the planks**. Leave a 10 mm gap between the planks and

the adjoining surface.

V. MAINTENANCE

- Sweep or vacuum daily using soft bristle attachments.
- Clean up spills and excessive liquids immediately.
- Damp mop as needed and use cleaners recommended for laminate flooring. Avoid using too much water.
- The use of residential steam mops on this product is allowed. Use at lowest power with a suitable soft pad, and do not hold a steam mop on one spot for an extended period of time (longer than 5 minutes). Refer to the steam mop's manufacturer instructions for proper usage.
- Use proper floor protection devices such as felt protectors under furniture.
- Place a walk-off mat at outside entrances to reduce the amount of dirt brought into your home. Do not use mats with a latex or rubber backing since these backings can cause permanent discoloration.
- Do not use scouring powder products, steel wool, abrasive cleaners, bleach or wax to maintain the floor.
- Do not drag or slide heavy objects across the floor.
- Never wax, polish or use soap. Doing so may damage the wear surface, causing it to be slippery or to have unattractive smudges.

VI. DISASSEMBLING

To disassemble, simply lift the planks one by one following the opposite sequence as the installation.